

Veinlite PEDI2®

DIRECTIONS FOR USE



Description

The TransLite Veinlite PEDI2 is a hand-held battery-powered transillumination device for visualizing veins and superficial blood vessels in pediatric patients.

The PEDI2 utilizes the patented¹ transillumination technique known as side-transillumination and a patented² orange color LED light. A ring of bright light from 10 orange and 4 red LEDs is aimed through a clear plastic LED Window [1] and focused below the skin surface and towards the ring's center. The focused light creates a volume of illumination, with the central focus acting as a virtual light source under the skin. This technique achieves uniform illumination of a small region of tissue anywhere on the body.

The patented orange light is selected because of high absorption in venous blood. The red LEDs have high penetration in darkly pigmented skins. The combination of the two provides optimum imaging of veins in humans.

INDICATIONS

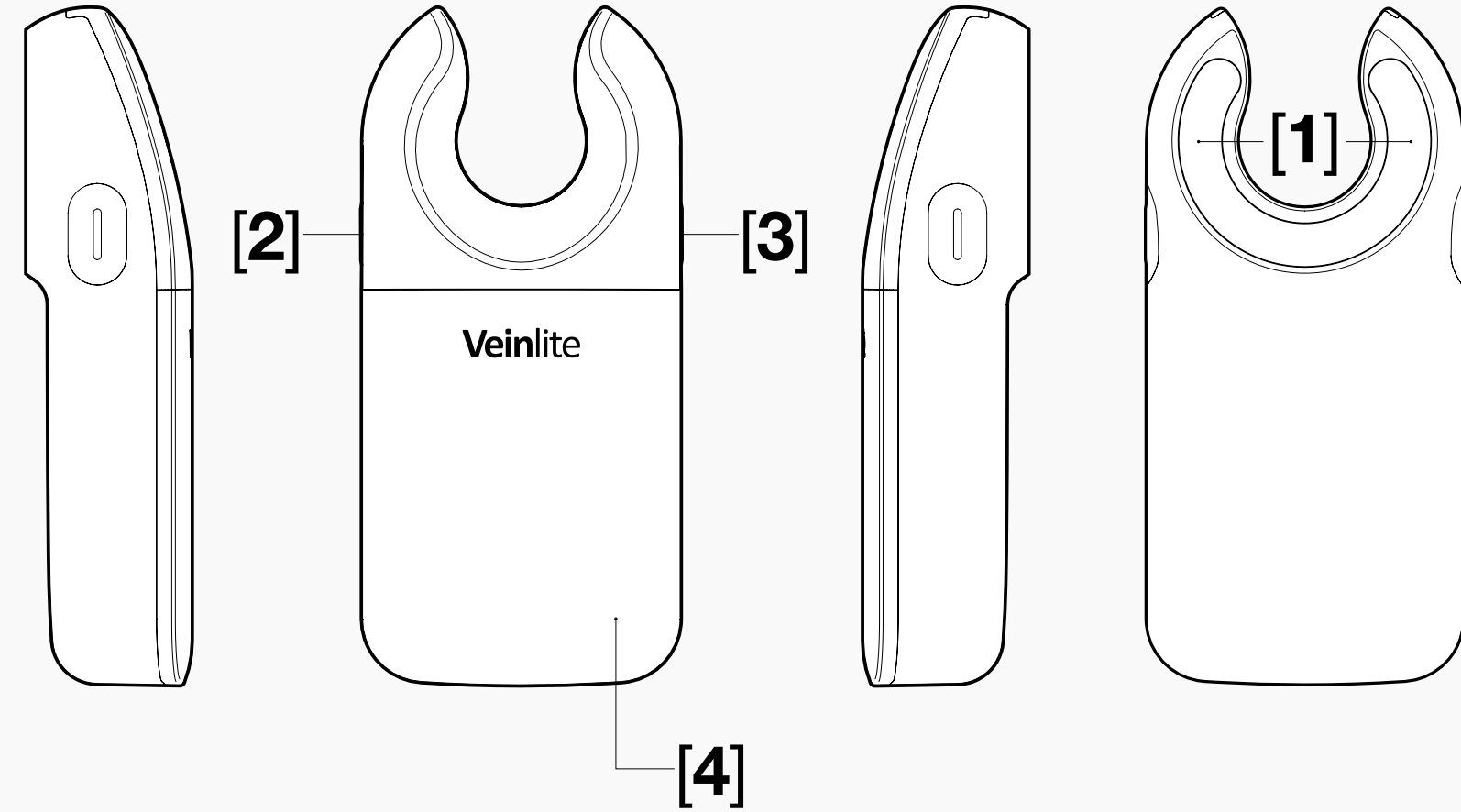

Figure 1. Veinlite PEDI2
 [1] Clear Window
 [2] Red Button
 [3] White Button
 [4] Battery Cover

Intended Use/Indications

- Emergency venous access in infants and children
- Venous access in infants and pediatric patients with a history of difficult venous access
- Easier visualization of veins in dark pigmented patients
- Easier visualization of veins in overweight infants and children

Contraindications

- When used for internal examination
- When used without the disposable plastic cover
- Not to be used near magnetic or electromagnetic fields

Specifications

Number of LEDs	10 Orange 4 Red
Weight with battery	29g
Dimensions	40.8 × 86.6 × 21 mm
Battery	2x AAA 1.5V

OPERATION

- Place the Veinlite PEDI2 inside the disposable plastic cover so that the device is totally covered.
- Place the Veinlite PEDI2 on the skin, with the LED Window [1] facing down. Apply gentle pressure to the Veinlite PEDI2 to ensure it is in contact with the skin.
- Depress the Power Button [2] to turn on the orange and then the red LEDs. Use the Brightness Button [3] to control the brightness level of the device to the desired level.

Power

Depressing the Power Button [2] turns on the orange LEDs. Depressing the button again, adds the red LEDs to the orange LEDs. Depressing the button again turn the unit off.

Depressing the Brightness Button [3] for one second will turn the unit off.

The LEDs will automatically shut off after 7 minutes.

Brightness Control

The Veinlite PEDI2 has three levels of brightness that are selected by pressing the Brightness Button [3] after the unit is turned on. Brightness control is important when working with small children.

- To scan for veins, place Veinlite PEDI2 against skin perpendicular to vein direction. Scan it forward and backward. Veins will be visible as dark lines due to transillumination.

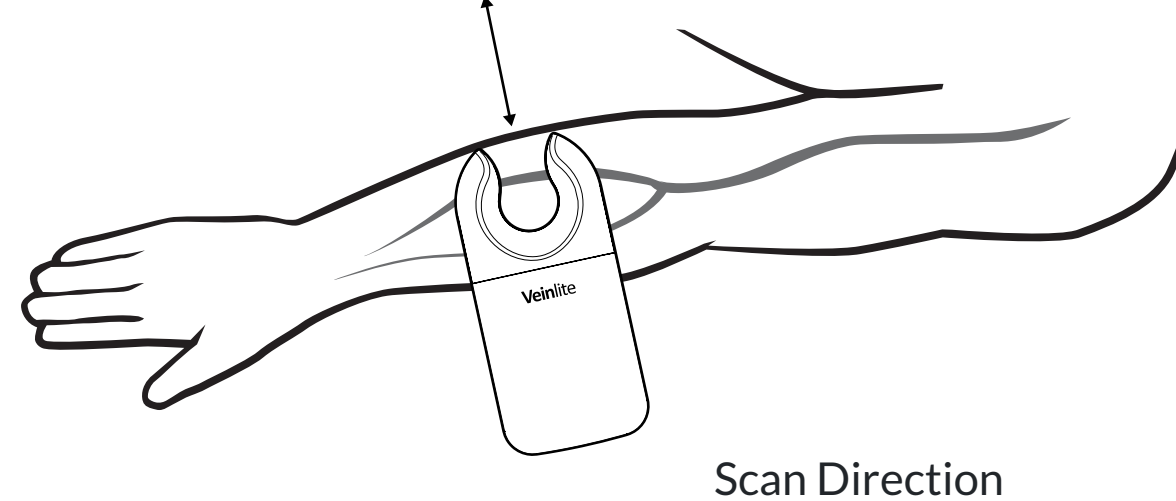

- Once a suitable vein has been identified, rotate device 90°, parallel to vein.

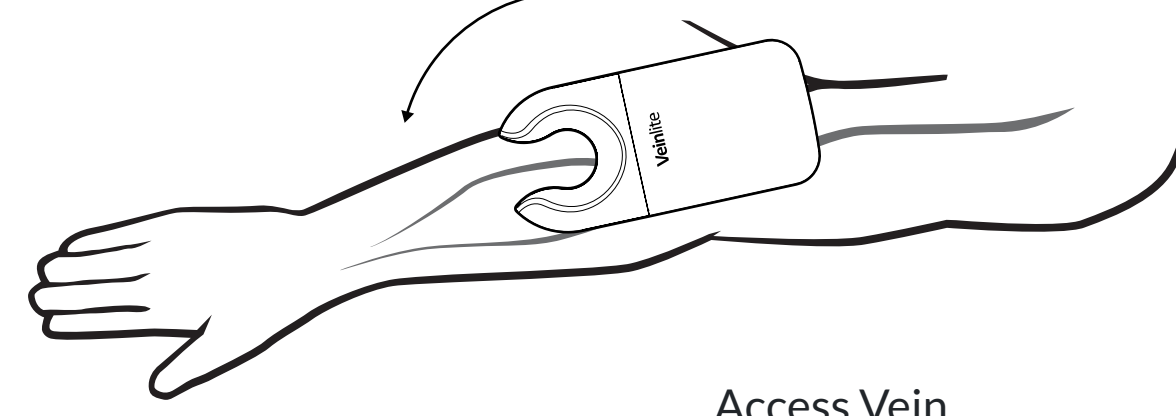

- Apply gentle pressure on the Veinlite PEDI2 to secure the vein.

- Push back slightly on the Veinlite PEDI2 to stretch the skin and provide traction.

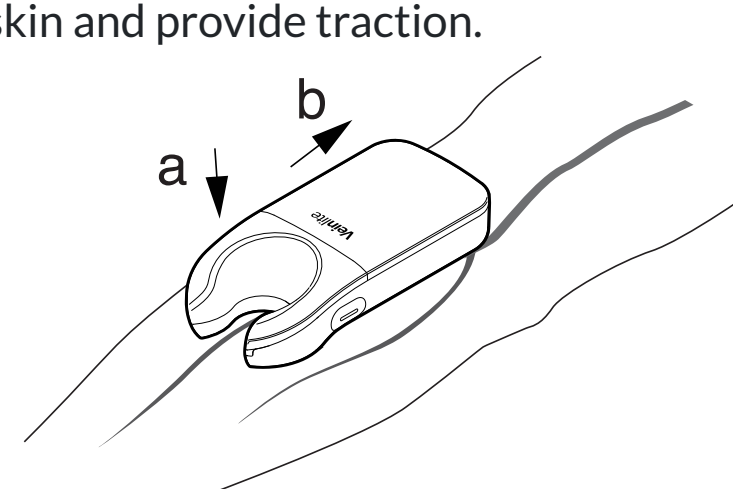

- Insert needle into vein, through the opening of device. NOTE: Discard single-use disposable plastic cover after each patient.

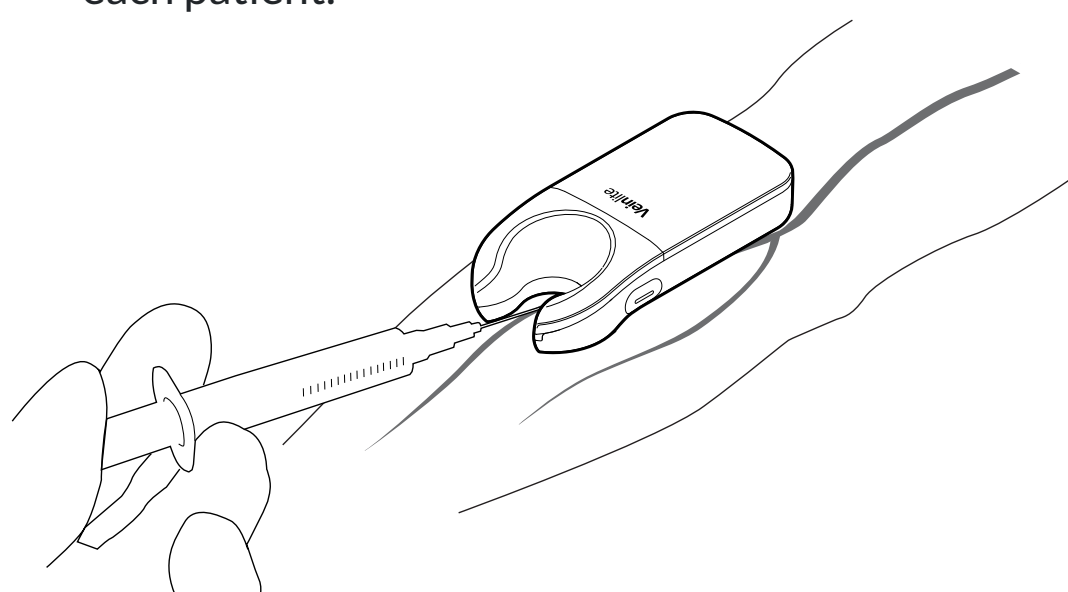

WARNING

DO NOT SHINE THE LED LIGHTS IN THE PATIENT'S EYES.

DISPOSABLE PLASTIC COVER

The single-use disposable plastic covers for the Veinlite PEDI2 (Product #VLP2-DPC) MUST be used when the device is placed in contact with a patient's skin.

CAUTION: These plastic covers are not sterile. They should be wiped with a germicidal wipe prior to use.

- Before using Veinlite PEDI2, place it inside the disposable cover with the flap on the same side as the LEDs.

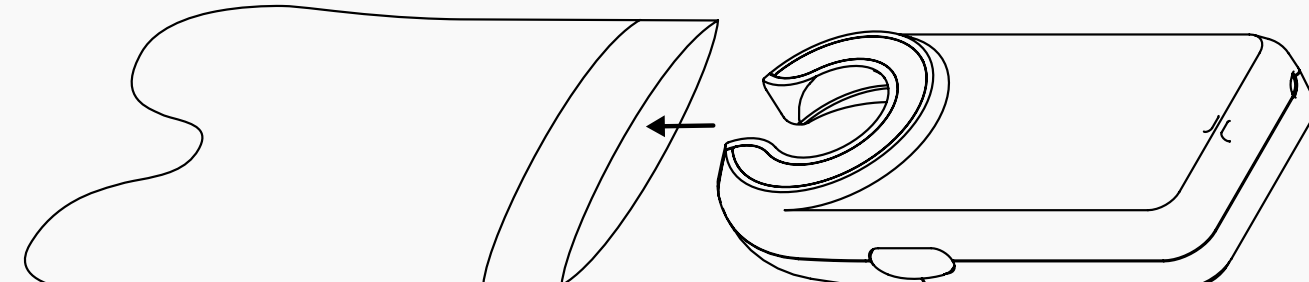

- Pull the flap over the device to the other side.

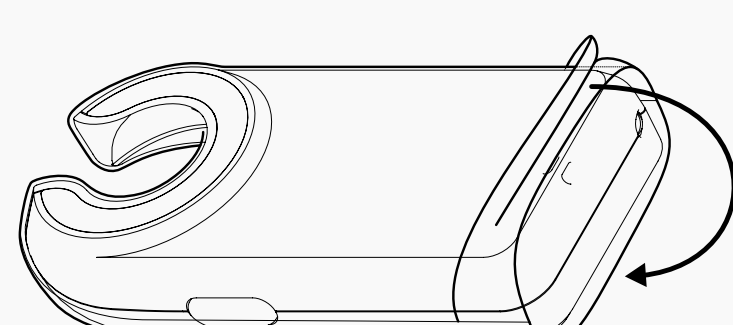

- Wipe the LED side of the Veinlite PEDI2 and any part of it coming in contact with the patient, with a medically approved germicidal wipe.

[Click here to re-order PEDI2 disposable plastic covers. US customers only.](#)

WARNING

Veinlite PEDI2 is designed for external examination only.

To avoid contamination of the device, Veinlite PEDI2 must be used with the disposable plastic cover.

To avoid the spread of infection, always change the disposable plastic cover between patients and wipe the new cover with a germicidal wipe.

These devices are intended for use only by clinicians trained in performing vascular access, or under the supervision of a clinician.

Do not look directly into LEDs while on.

Device may be wiped down with a germicidal wipe.

Do not immerse the device in liquid.

Do not autoclave the device

Contact TransLite about adverse event in relation to this device. Should adverse event occur in E.U., notify EU Competent Authority.

BATTERIES

The Veinlite PEDI2 is powered by 2 AAA batteries. They provide between 2 and 4 hours of continuous illumination depending on the number of LEDs turned on and the brightness level used.

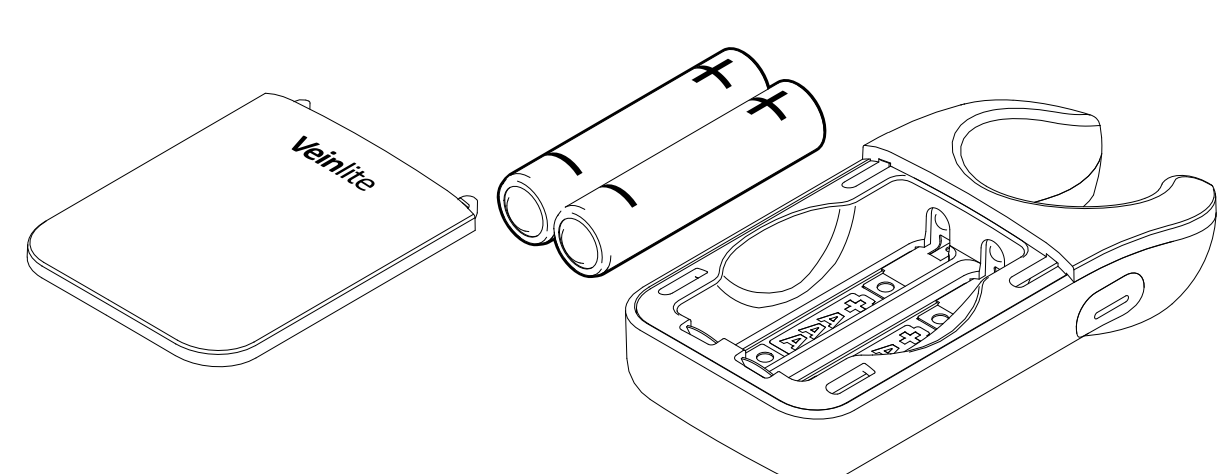

Low Battery Indicator

When the batteries get low, the orange lights will flicker when turned on. Replace the batteries as soon as the orange light flickers when turned on.

Installing Or Replacing Batteries

To install or replace the batteries, press firmly on the Battery Cover [4] and slide it off. Remove any used batteries. Install 2 new AAA batteries, oriented as indicated by the markings inside the battery compartment then slide the battery cover back into place.

WARRANTY INFORMATION

Warranty

The Veinlite PEDI2 has a one-year parts and labor warranty. It is not necessary to register your Veinlite PEDI2 for warranty. The process is automatic, and the serial number of the unit provides all the information needed.

Troubleshooting

Before returning the device to TransLite for repair, please call or e-mail to obtain an authorization number and shipping details.

No refunds will be given for devices shipped without authorization.

EXPLANATION OF SYMBOLS

Model Number

Serial Number

Manufacturer

EC Representative (EU Only)

Do not dispose of as unsorted municipal waste

Temp -20C/68F to +50C/122F

Humidity 45-80%

Pressure 500 – 1060hPa

Keep dry

Manufacturer date

Do Not reuse

Electronic instructions available

Medical Device

MR Unsafe

Not made with natural rubber latex

EC REP EC Rep LTD
 5 Fitzwilliam Square East
 Dublin 2 D02 R744
 Ireland
 Tel: +353 89 225 1951
 info@ecrep.ie

CH REP E C Rep Gm bH
 580 Badenerstrasse
 8048 Switzerland
 info@ch-rep.info

UK CA Responsible Person in the UK
 Responsible Person Limited
 Summit House, 4-5 Mitchell
 Street, Edinburgh, EH6 7BD,
 Scotland

TransLite LLC
 Tel: (281) 240 3111
 Fax: (281) 240 3122
 www.veinlite.com
 info@veinlite.com

¹ US Patent Number 5,146,923
² US Patent Number 7,874,698

VP2 DFU Rev3 0322

Made in USA